

Quantum computing for computational finance

overview, challenges and opportunities

Álvaro Leitao



International Conference on Computational Finance (ICCF) 2024

April 2, 2024

Motivation

- Quantum computers could bring unparalleled competitive advantage to financial companies in areas like portfolio optimisation, option pricing, quantitative risk management or Machine Learning models.
- Quantum computers are able to handle exponentially growing (in qubits) Hilbert spaces.
- Thus, quantum computing becomes an attractive framework for calculations over large multi-dimensional domains.
- Quantum algorithms could potentially overcome their classical counterparts in dealing with combinatorial explosions and the curse of dimensionality.
- However, bringing this to practice encounters several bottlenecks, especially with the current or near-term quantum technologies (NISQ).
- Then, plenty of room for contributions!

- Quantum computing literature is experiencing an explosion: This overview incorporates only a few of the current trends.
- The selection of the addressed topics reflects only my view (interests) within the vast scope of the computational finance field.
- Then, many important topics are not addressed here: optimal investment, time series, blockchain, cryptography, etc.
- There might be inconsistencies or certain abuse in the (mathematical and/or quantum) notation. In some cases, that is intentional, for the sake of clarity. In others...sorry in advance!

Quantum Computing basics

Overview

- Quantum Monte Carlo

- Quantum Financial PDEs

- Quantum Machine/Deep Learning

Challenges

Opportunities

Quantum Computing basics

Quantum Computing basics (I)

- The basic unit of information is the *qubit* (alternatively to the *bit*).
- A qubit is represented by a (column) vector:

$$\begin{pmatrix} \alpha \\ \beta \end{pmatrix}$$

with the *amplitudes* $\alpha, \beta \in \mathbb{C}$ and $|\alpha|^2 + |\beta|^2 = 1$.

- Basis states:

$$|0\rangle = \begin{pmatrix} 1 \\ 0 \end{pmatrix}, \quad |1\rangle = \begin{pmatrix} 0 \\ 1 \end{pmatrix}$$

- $\{|0\rangle, |1\rangle\}$ is a computational basis for a quantum state:

$$|\psi\rangle = \alpha |0\rangle + \beta |1\rangle$$

- When *measuring* the state:
 - get 0 with probability $|\alpha|^2$
 - get 1 with probability $|\beta|^2$

Quantum Computing basics (II)

- The Bloch sphere provides a representation of qubit state
- Measuring a qubit occurs along the Z axis, so it is irreversible and will collapse to either 0 or 1

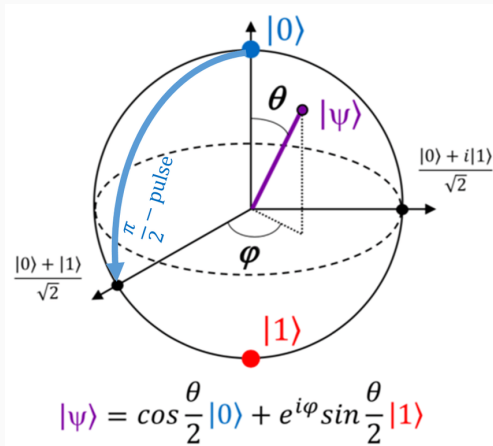

Quantum Computing basics (II)

- The Bloch sphere provides a representation of qubit state
- Measuring a qubit occurs along the Z axis, so it is irreversible and will collapse to either 0 or 1

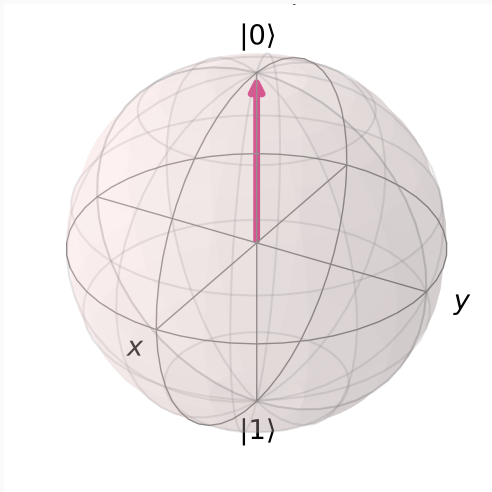

Quantum Computing basics (II)

- The Bloch sphere provides a representation of qubit state
- Measuring a qubit occurs along the Z axis, so it is irreversible and will collapse to either 0 or 1

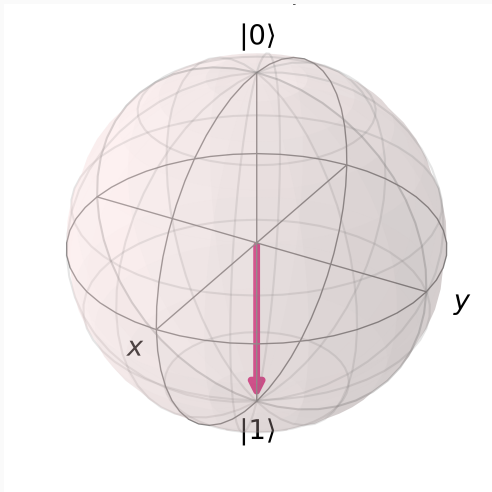

Quantum Computing basics (III)

- Quantum gates to perform operations on qubits
- Gates are reversible and can be represented as unitary matrices acting on the qubit vectors.

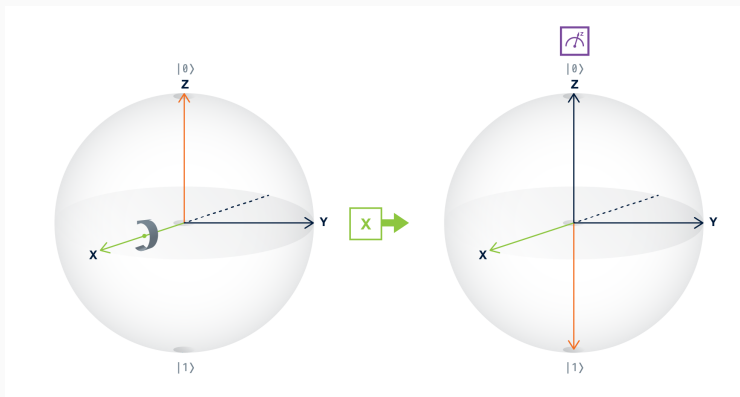

Quantum Computing basics (III)

- Quantum gates to perform operations on qubits
- Gates are reversible and can be represented as unitary matrices acting on the qubit vectors.

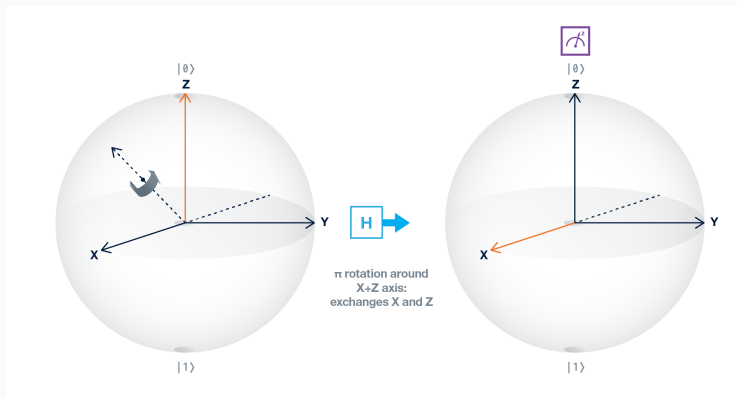

Quantum Computing basics (IV)

- Superposition: Identically prepared qubits can still behave randomly
- The randomness is inherent in the quantum nature

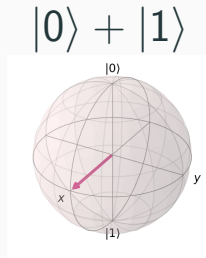
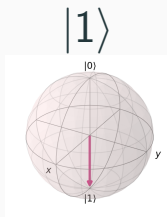
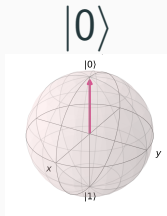

\sim 50/50 chance of
being $|0\rangle$ or $|1\rangle$

Quantum Computing basics (and V)

- Each row represents a bit, either quantum or classical
- The operations are performed each qubit from left to right
- Measurement to extract the information

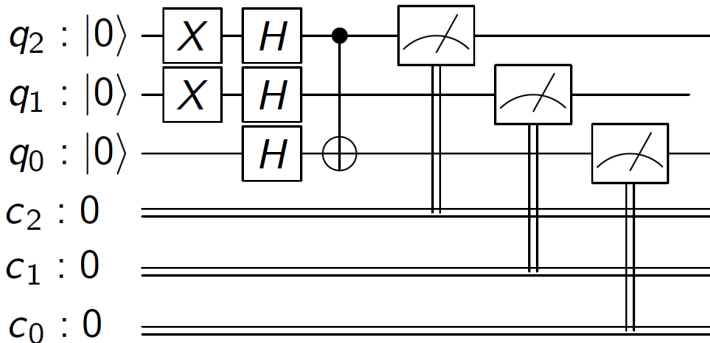

Quantum Computing basics (and V)

- Each row represents a bit, either quantum or classical
- The operations are performed each qubit from left to right
- Measurement to extract the information

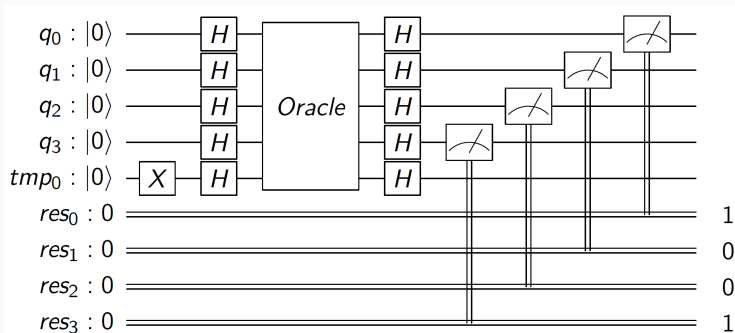

Overview

- Based on the publication [11]:
A. Gómez, Á. Leitaó, A. Manzano, D. Musso, M.R. Nogueiras, G. Ordóñez and C. Vázquez. **A survey on quantum computational finance for derivatives pricing and VAR**, *Archives of Computational Methods in Engineering* 29: 4137-4163, 2022.
- Survey on the classical methods for pricing and VaR, and their potential quantum counterparts.
- We mainly focus on:
 - Monte Carlo-like methods.
 - Partial differential equations (PDEs).
 - Machine Learning/Neural Networks/Deep Learning.

Quantum Monte Carlo

Quantum Monte Carlo (QMC)

The quantum-accelerated Monte Carlo could potentially/theoretically provide a quadratic speedup.

How? Quantum Amplitude Estimation.

Monte Carlo methods (for pricing) can be informally defined as

$$\frac{1}{M} \sum_{i=0}^{M-1} f(X_i) \approx \mathbb{E}[f(X)] = \int f(x)p(x)dx \approx \sum_{j=0}^{N-1} f(x_j)p(x_j)$$

where $p(x)$ is a density function.

Analogously, Quantum Monte Carlo (QMC) assumes a state of the form

$$|\psi\rangle = |0\rangle \otimes \sum_{j=0}^{N-1} f(x_j)p(x_j) |j\rangle + |1\rangle \otimes \sum_{j=0}^{N-1} \sqrt{1 - f^2(x_j)p(x_j)} |j\rangle$$

where the quantity of interest is encoded in the state's amplitude.

QMC: Quantum Amplitude Estimation

Given a state:

$$|\psi\rangle = a|\phi\rangle + \sqrt{1-a^2}|\phi^\perp\rangle,$$

Quantum Amplitude Estimation (QAE) is an algorithm which gives an estimation $\hat{a} \pm \frac{\epsilon}{2}$ of the amplitude a .

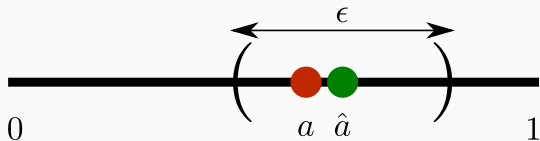

This technique promises to obtain a **quadratic speedup over its classical counterpart**.

To achieve so it relies on two main subroutines:

- Grover (search) amplification.
- Quantum Phase Estimation.

QMC: Grover Amplification

Given a state:

$$|\psi\rangle = \sin(\theta) |\phi\rangle + \cos(\theta) |\phi^\perp\rangle,$$

Grover operator performs the following transformation:

$$\mathcal{Q}^k |\psi\rangle = \sin((2k + 1)\theta) |\phi\rangle + \cos((2k + 1)\theta) |\phi^\perp\rangle.$$

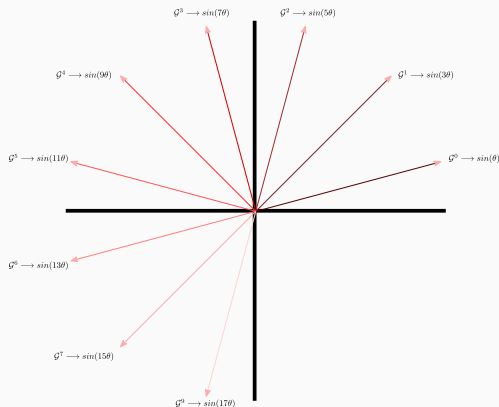

QMC: Quantum Amplitude Estimation (graphically)

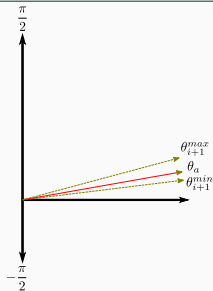
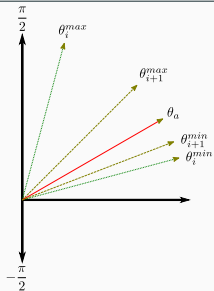
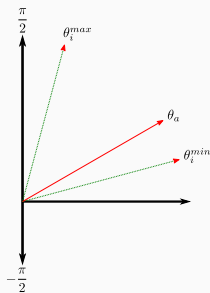
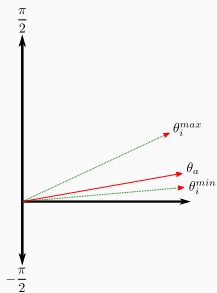

QMC: Quantum Amplitude Estimation (circuit)

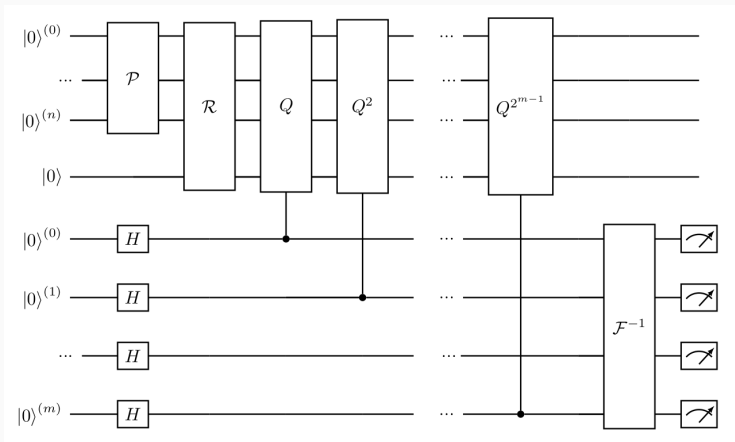

Figure 1: Quantum Amplitude Estimation

QMC: Quantum Amplitude Estimation (convergence)

Theorem (Mean estimation for $[0, 1]$ bounded functions [25])

Let there be given a quantum circuit \mathcal{P} on n qubits. Let $v(\mathcal{P})$ be the random variable that maps to $v(x) \in [0, 1]$ when the bit string x is measured as the output of \mathcal{P} . Let \mathcal{R} be defined as

$$\mathcal{R} |x\rangle |0\rangle = |x\rangle \left(\sqrt{1 - v(x)} |0\rangle - \sqrt{v(x)} |1\rangle \right).$$

Let $|\mathcal{X}\rangle$ be defined as $|\mathcal{X}\rangle = \mathcal{R}(\mathcal{P} \otimes \mathcal{I}_2) |0^{n+1}\rangle$. Set $\mathcal{U} = \mathcal{I}_{2^{n+1}} - 2|\mathcal{X}\rangle\langle\mathcal{X}|$. There exists a quantum algorithm that uses $\mathcal{O}(\log 1/\delta)$ copies of the state \mathcal{X} , uses \mathcal{U} for a number of times proportional to $\mathcal{O}(m \log 1/\delta)$ and outputs an estimate $\hat{\mu}$ such that

$$|\hat{\mu} - \mathbb{E}[v(\mathcal{P})]| \leq C \left(\frac{\sqrt{\mathbb{E}[v(\mathcal{P})]}}{m} + \frac{1}{m^2} \right),$$

with probability at least $1 - \delta$, where C is a universal constant. In particular, for any fixed $\delta > 0$ and any ϵ such that $0 < \epsilon \leq 1$, to produce an estimate $\hat{\mu}$ such that, with probability at least $1 - \delta$, $|\hat{\mu} - \mathbb{E}[v(\mathcal{P})]| \leq \epsilon \mathbb{E}[v(\mathcal{P})]$, it suffices to take $m = \mathcal{O}((\epsilon \mathbb{E}[v(\mathcal{P})])^{-1})$. To achieve $|\hat{\mu} - \mathbb{E}[v(\mathcal{P})]| \leq \epsilon$ with probability at least $1 - \delta$, it suffices to take $m = \mathcal{O}(\epsilon^{-1})$.

- Quantum Amplitude Estimation is not feasible with the current technology as it depends on Quantum Phase Estimation.
- The depth of the circuit due to the use of a Quantum Fourier Transform (QFT) is prohibitive.
- To mitigate it several new techniques have appeared:
 - Simplified Quantum Counting (SQAE)[1]
 - Maximum Likelihood Amplitude Estimation (MLAE)[34, 35]
 - Iterative Quantum Amplitude Estimation (IQAE)[14]
- We have proposed another alternative [23]:
A. Manzano, D. Musso, Á. Leitao. **Real Quantum Amplitude Estimation** , *EPJ Quantum Technology* 10(2), 2023.

RQAE: Settings

- Consider a one-parameter family of oracles \mathcal{A}_b that, acting on the state $|0\rangle$, yield

$$\mathcal{A}_b |0\rangle = |\psi\rangle = (a + b) |\phi\rangle + c_b |\phi^\perp\rangle_b ,$$

where a is a real number, b is an auxiliary, continuous and real parameter that we call “shift”.

- Given a precision level ϵ and a confidence level $1 - \gamma$, the goal of the RQAE algorithm is to compute an interval $(a_I^{\min}, a_I^{\max}) \subset [-1, 1]$ of width smaller than 2ϵ which contains the value of a with probability greater or equal to $1 - \gamma$.

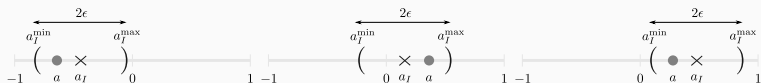

RQAE: Algorithm (graphically)

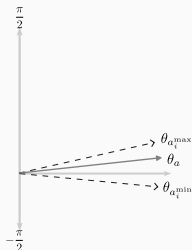

(a) Starting point.

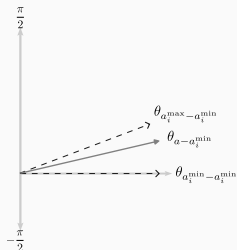

(b) Shift.

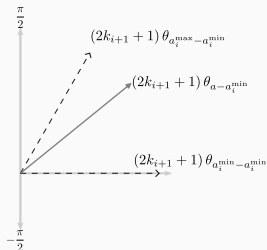

(c) Amplification.

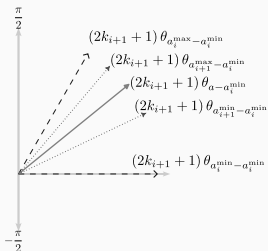

(d) Measuring.

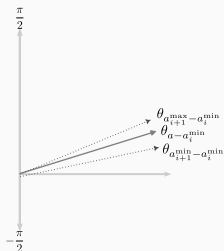

(e) Undoing amplification.

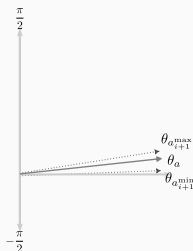

(f) Undoing shift.

RQAE: Main properties

Given ϵ, γ and an amplification policy $(k_i, i = 0, \dots, l)$:

- Circuit depth bounded by:

$$k_l \leq \left\lceil \frac{\arcsin(\sqrt{2\epsilon^p})}{\arcsin(2\epsilon)} - \frac{1}{2} \right\rceil = k^{\max}.$$

- Precision ϵ with confidence $1 - \gamma$ (Proof of Correctness):

$$\mathbb{P}\left[a \notin (a_l^{\min}, a_l^{\max})\right] \leq \gamma.$$

- The total number of calls to the oracle is bounded by:

$$N_{\text{oracle}} < C_1 \frac{1}{\epsilon} \log\left(\frac{C_2}{\gamma}\right),$$

where the constants C_1 and C_2 depend on the amplification policy.

RQAE: Numerical results (I)

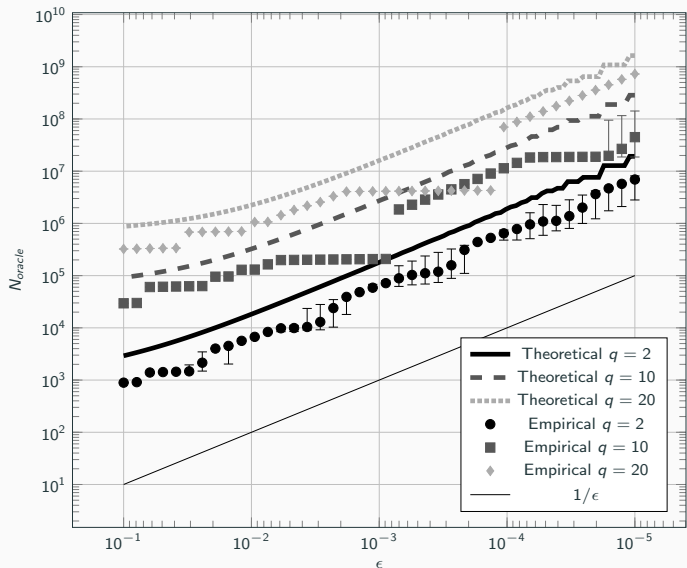
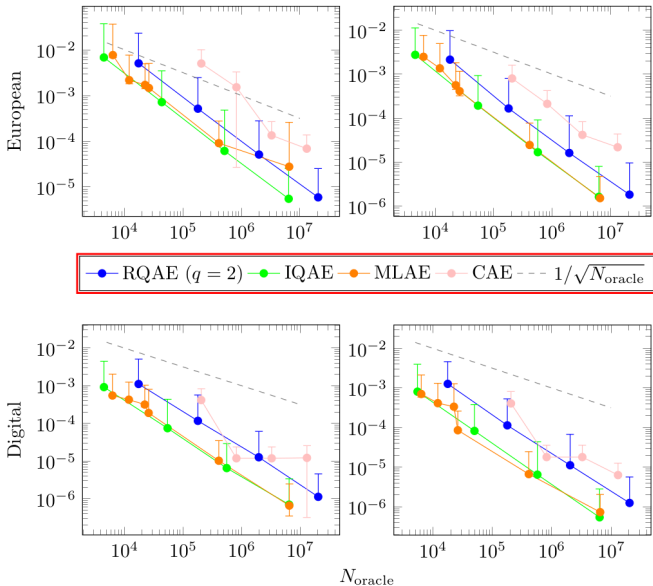

Figure 2: Number of calls to the oracle N_{oracle} versus the required precision ϵ .

RQAE: Numerical results (and II)

$$\left| \sum_{k=0}^{\mathcal{K}-1} p_S(S_k) F(S_k) - \sqrt{\bar{P}_0} \right|$$



RQAE: Main Conclusions

- More information from the quantum circuit than just the module of the amplitude, i.e., the sign of the quantity of interest, increasing the applicability.
- RQAE is an iterative algorithm which offers explicit control over the amplification policy through adjustable parameters.
- Control (also via the free parameters) the depth of the circuit, a crucial feature in the current NISQ era.
- A rigorous (and clean) theoretical analysis of the RQAE performance is provided, proving that it achieves a quadratic speedup (w.r.t. unamplified sampling), modulo logarithmic corrections.

Quantum Financial PDEs

Quantum approaches for Black-Scholes PDE

- Some financial PDEs can be mapped into the propagation governed by an appropriate Hamiltonian operator [12, 9].
- Applying the change of variable $S = e^x$ on the Black-Scholes eq.,

$$\frac{\partial V}{\partial t} + \left(\mu - \frac{\sigma^2}{2} \right) \frac{\partial V}{\partial x} + \frac{\sigma^2}{2} \frac{\partial^2 V}{\partial x^2} - \mu V = 0 ,$$

which can be written as a Schrödinger-like equation,

$$\frac{\partial V}{\partial t} = -i\hat{H}_{\text{BS}} V ,$$

where

$$\hat{H}_{\text{BS}} = i\frac{\sigma^2}{2}\hat{p}^2 - \left(\frac{\sigma^2}{2} - \mu \right) \hat{p} + i\mu\mathbb{I} , \quad \text{with} \quad \hat{p} = -i\frac{\partial}{\partial x} .$$

- The Hamiltonian \hat{H}_{BS} is *not* Hermitian.
- Therefore, the associated evolution operator $\hat{U}(t, t_0) = e^{-i\hat{H}_{\text{BS}}(t-t_0)}$ is not unitary.

PDEs: Real-time propagation

- To implement $\hat{U}(t, t_0)$ into a quantum circuit, one can consider an enlarged system, i.e. a doubled unitary operator [12].
- Require of adding an auxiliary qubit.
- \hat{H}_{BS} is diagonal in momentum space \rightarrow diagonal operator \rightarrow QFT (and Inverse QFT) \rightarrow exponential speedup.
- But, an overall exponential speedup requires efficient loading of the model and payoff function.
- Again, QFT (IQFT) is gate-wise demanding (incompatible NISQ).

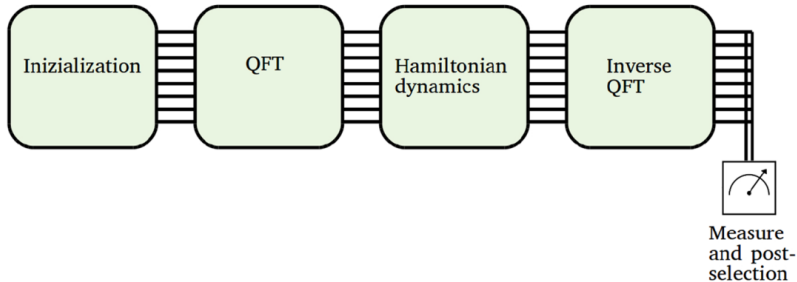

PDEs: Real-time propagation (solution)

- The algorithm achieves a high degree of agreement in a fault-tolerant quantum computer...
- ...but with a 60% success probability in the measurement and post-selection (depending on the financial parameters).
- Not tested in a real NISQ quantum system.

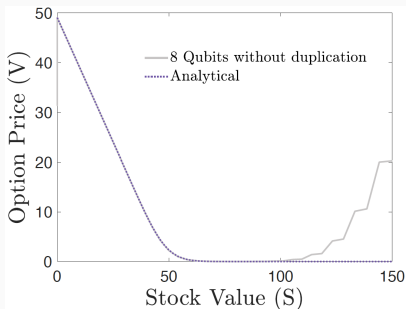

(a) Boundary error without duplication.

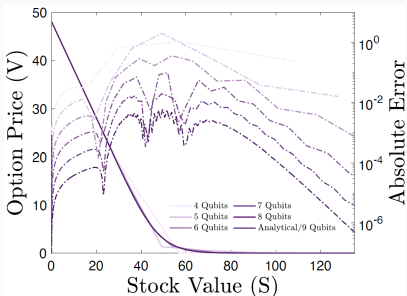

(b) Convergence in qubits (point).

PDEs: Imaginary-time propagation

- Additional change of variable $\tau = \sigma^2(T - t)$ and transformation $v(x, \tau) = \exp(-ax - b\tau)V(t, s)$, with suitable constants a and b ,

$$\frac{\partial v}{\partial \tau} = \frac{1}{2} \frac{\partial^2 v}{\partial x^2} .$$

- Using the Wick rotation $\tilde{\tau} = -i\tau$ (real time to imaginary time), the heat equation turns into a Schrödinger-like equation,

$$\frac{\partial v}{\partial \tilde{\tau}} = -\hat{H}_{\text{HE}} v ,$$

where

$$\hat{H}_{\text{HE}} = -\frac{i}{2} \hat{q}^2 , \quad \text{with} \quad \hat{q} = -i \frac{\partial}{\partial x} .$$

- This leads to a purely anti-Hermitian Hamiltonian operator.
- Imaginary-time propagation transforms oscillations into dampings.
- Problem of finding the ground state of quantum systems, well investigated in condensed matter physics and chemistry.
- The imaginary time evolution operator is approximated by an ansatz circuit in [9].

PDEs: Imaginary-time propagation (solution)

- The solution is retrieved by a hybrid quantum-classical algorithm:

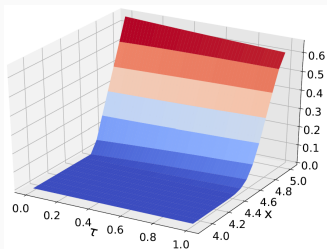
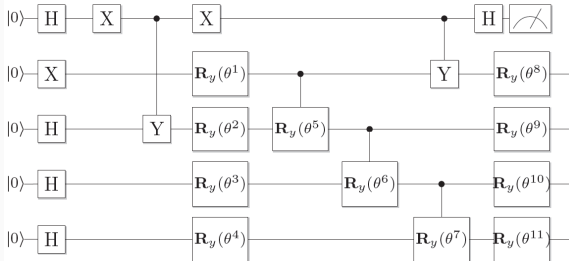

(c) Prices of European option.

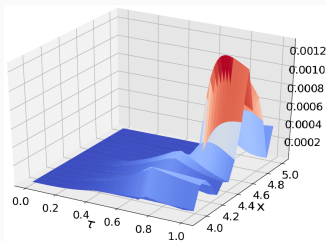

(d) Errors of European option.

Quantum Machine/Deep Learning

Quantum Machine/Deep Learning

- (Quantum) Principal Component Analysis:
 - Eigenvalues by Quantum Phase Estimation [27].
 - Convert covariance matrix into density matrix (QPCA) [20, 2].
- (Quantum) Regression:
 - Solving linear systems by the HHL algorithm [37].
 - Quantum Kernel Estimation [8].
 - Quantum regression with Gaussian processes [38].
- Hybrid classical-quantum deep learning:
 - Move the training to a quantum computer (quantum annealing) [3].
 - Quantum-enhanced reinforcement learning [29].
 - Quantum GANs [26].
 - Boltzman machines \rightarrow Born machines [36, 4].
- Full Quantum Neural Network (QNN):
 - NN models based on the principles of quantum mechanics [17].
 - How to train QNN? Recent advances in [6, 7].
- Promising approach: *Parametrized Quantum Circuits*

Parametrized Quantum Circuits (PQCs)

- Also known as *variational circuits* or *quantum circuit learning*.
- First theoretical results on *accessibility*, *expressivity* and *universality*.
- Circuits with both fixed and adjustable (“parametrized”) gates.
- The training is carried out by a classical optimiser.
- Each layer composed by a trainable circuit block $W_i(\theta)$ and a data-encoding block $S(x)$:

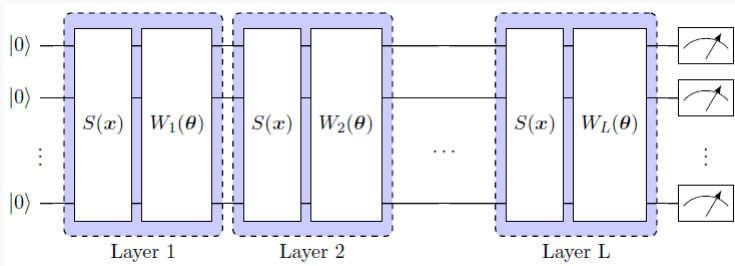

Figure 3: Parametrized Quantum Circuit.

- A PQC model can be written as a generalized trigonometric series:

$$\mathbb{E}[M] = \langle 0 | U^\dagger(\mathbf{x}; \boldsymbol{\theta}) M U(\mathbf{x}; \boldsymbol{\theta}) | 0 \rangle = f(\mathbf{x}; \boldsymbol{\theta}) = \sum_{\boldsymbol{\omega} \in \Omega} c_{\boldsymbol{\omega}}(\boldsymbol{\theta}) e^{i\boldsymbol{\omega}\mathbf{x}},$$

where M is an observable, $U(\mathbf{x}; \boldsymbol{\theta})$ is a quantum circuit that depends on inputs $\mathbf{x} = (x_0, x_1, \dots, x_N)$ and the parameters $\boldsymbol{\theta} = (\theta_0, \theta_1, \dots, \theta_T)$.

- Accessibility: with $\Omega \subset \mathbb{Z}^N \rightarrow$ (partial) Fourier series!
- The coefficients $c_{\boldsymbol{\omega}}$ determine the expressivity (how the accessible functions can be combined).
- But the expressivity is also limited by the data encoding strategy.
- Universality: the Fourier series formalism allows to study quantum models using the results in Fourier analysis (see [30] and [21]).

PQCs: Universality results (I)

Definition

Let $U(\mathbf{x}; \boldsymbol{\theta})$ be modelled as a unitary such that (1 layer):

$$U(\boldsymbol{\theta}, \mathbf{x}) = W^{(2)}(\boldsymbol{\theta}^{(2)})S(\mathbf{x})W^{(1)}(\boldsymbol{\theta}^{(1)}),$$

and

$$S(\mathbf{x}) = e^{-x_1 H} \otimes \dots \otimes e^{-x_N H} =: S_H(\mathbf{x})$$

where H is a particular Hamiltonian.

Definition

Let $\{H_m | m \in \mathbb{N}\}$ be a Hamiltonian family where H_m acts on m subsystems of dimension d . Such a Hamiltonian family gives rise to a family of models $\{f_m\}$ in the following way:

$$f_m(\mathbf{x}) = \langle \Gamma | S_{H_m}^\dagger(\mathbf{x}) M S_{H_m}(\mathbf{x}) | \Gamma \rangle. \quad (1)$$

with $|\Gamma\rangle := W^{(1)}(\boldsymbol{\theta}^{(1)})|0\rangle$.

PQCs: Universality results (II)

Theorem (Convergence in L^2 [30])

Let $\{H_m\}$ be a universal Hamiltonian family, and $\{f_m\}$ the associated quantum model family, defined via (1). For all functions $f^* \in L^2([0, 2\pi]^N)$, and for all $\epsilon > 0$, there exists some $m' \in \mathbb{N}$, some state $|\Gamma\rangle \in \mathbb{C}^{m'}$ and some observable M such that

$$\|f_{m'} - f^*\|_{L^2} < \epsilon.$$

Theorem (Convergence in L^p [21])

Let $\{H_m\}$ be a universal Hamiltonian family, and $\{f_m\}$ the associated quantum model family, defined via (1). For all functions $f^* \in L^p([0, 2\pi]^N)$ where $1 \leq p < \infty$, and for all $\epsilon > 0$, there exists some $m' \in \mathbb{N}$, some state $|\Gamma\rangle \in \mathbb{C}^{m'}$, and some observable M such that:

$$\|f_{m'} - f^*\|_{L^p} < \epsilon.$$

Theorem (Convergence in C^0 [21])

Let $\{H_m\}$ be a universal Hamiltonian family, and $\{f_m\}$ the associated quantum model family, defined via (1). For all functions $f^* \in C^0(U)$ where U is compactly contained in the closed cube $[0, 2\pi]^N$, and for all $\epsilon > 0$, there exists some $m' \in \mathbb{N}$, some state $|\Gamma\rangle \in \mathbb{C}^{m'}$, and some observable M such that $f_{m'}$ converges uniformly to f^* :

$$\|f_{m'} - f^*\|_{C^0} < \epsilon,$$

with

$$\|f_{m'} - f^*\|_{C^0} := \sup_{\mathbf{x} \in [0, 2\pi]^N} \|f_{m'}(\mathbf{x}) - f^*(\mathbf{x})\|.$$

Challenges

Discussion on Quantum Monte Carlo

Is the Quantum Monte Carlo what we (computational finance community) expect?

In [33] they divide the routine for computing the price of a plain vanilla in three steps:

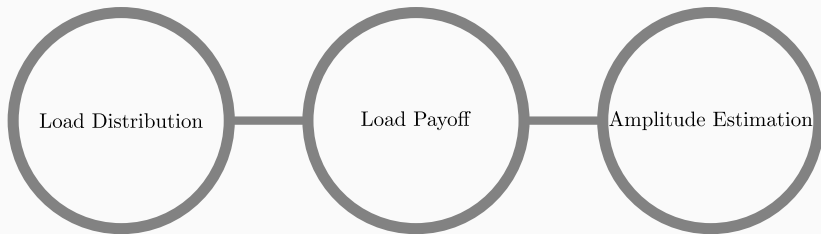

They **promise a quadratic speedup over classical Monte Carlo**:

"This represents a theoretical quadratic speed-up compared to classical Monte Carlo methods."

Classical Monte Carlo vs Quantum Monte Carlo

When claiming a **“quadratic”** speedup of the QMC over the Classical, **what are they comparing?**

Steps involved in Classical and Quantum Monte Carlo :

Quantum Monte Carlo	Classical Monte Carlo
Load Distribution	Load parameters... Simulate the paths
Load Payoff	Compute payoff
Amplitude Estimation	Sum over paths Print the results

“In most of the existing literature on option pricing for equities using quantum computers... an SDE is tacitly solved... Once this SDE is solved... the pricing of a particular security begins by applying QAE.[5]”

Bottleneck

The bottleneck in Classical Monte Carlo is in simulating paths. **Analogously**, the bottleneck in the quantum algorithm is in the loading/simulation/computation of the distribution.

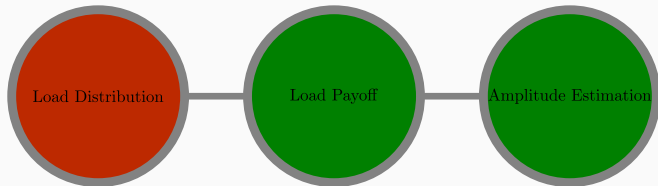

The quantum advantage might disappear when taking into account the cost of simulation:

“Although preparing such states is in principle always possible for reasonable stochastic processes, efficient realization of this method demands a careful analysis and may not always result in a practical quantum advantage.” (see [5])

Quantum Algorithm Pipeline

Quantum advantage of an algorithm? Efficient end-to-end framework!

We propose (in [22], inspired in [8]) a pipeline as:

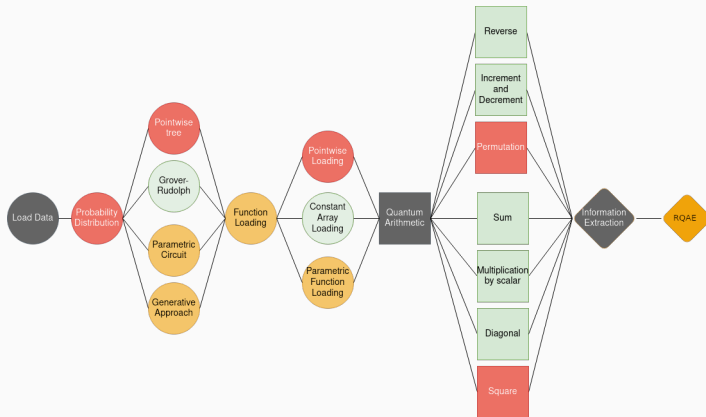

- Focus on specific problems → **Modularity**
- Use algorithms from other works → **Reusability**

Other challenges for problems in quantitative finance

- Data loading for Quantum Machine Learning models.
- Quantum-native function implementations (using unitary transforms).
- Information extraction from a quantum state:
 - QAE can be seen as an efficient information extraction routine
 - Post selection in PDE-Hamiltonian simulation algorithms?
- Rigorous proofs for:
 - Speedups (quantum advantage)
 - Estimation convergence
 - Circuits complexity (depth)
- Quantum volume (NISQ):
 - Intrinsic noisy of the current quantum systems (the shallower the better)
 - Limited number of qubits (i.e. to represent floating-point numbers)
 - Others: coherence time, measurement errors, circuit compiler efficiency, etc.

Opportunities

Opportunities

- Quantum Monte Carlo: All the described above!
- PDEs:
 - Mapping to linear systems (classical numerical methods)
 - Proofs of algorithm complexity (close to exponential speedup?)
- Proofs for the universality/expressivity of quantum DL models:
 - Theory behind the general reproducing kernels
- Adapt/use QML algorithms for financial applications.
- Efficient quantum versions of successful classical algorithms:
 - Quantum COS
 - PINNs
 - Differential Machine Learning
- Other:
 - Alternatives to Harrow-Hassidim-Lloyd (HHL) for linear systems.
 - Similar opportunities in optimization algorithms.
- At practical level: NISQ era!

Conclusions

- In recent years we have seen significant advances in quantum algorithms with application to financial mathematical problems.
- While this progress is very encouraging, further work will be required to prove that Quantum Computing can deliver real-world advantage.
- Especially if this advantage is to be delivered on NISQ technology with limitations to both the number of logical qubits and the depth of quantum circuits.
- Research into financial applications of quantum computing is accelerating with new ideas emerging at rapid pace...
- ...but important breakthroughs across the technology stack will be needed to make the approaches viable.
- Theory/software is ahead of practice/hardware!

Dank u wel!!

More: `alvaro.leitao@udc.gal` and `alvaroleitao.github.io`

Thanks to the support of Centre for Information and Communications Technology Research (CITIC). CITIC is funded by the Xunta de Galicia through the collaboration agreement between the Consellería de Cultura, Educación, Formación Profesional e Universidades and the Galician universities for the reinforcement of the research centres of the Galician University System (CIGUS).

- [1] S. Aaronson and P. Rall.
Quantum approximate counting, simplified.
ArXiv, abs/1908.10846, 2020.
- [2] J. Abhijith, A. Adedoyin, J. Ambrosiano, P. Anisimov, A. Bärtschi, W. Casper, G. Chennupati, C. Coffrin, H. Djidjev, D. Gunter, S. Karra, N. Lemons, S. Lin, A. Malyzhenkov, D. Mascarenas, S. Mniszewski, B. Nadiga, D. O'Malley, D. Oyen, S. Pakin, L. Prasad, R. Roberts, P. Romero, N. Santhi, N. Sinitsyn, P. J. Swart, J. G. Wendelberger, B. Yoon, R. Zamora, W. Zhu, S. Eidenbenz, P. J. Coles, M. Vuffray, and A. Y. Lokhov.
Quantum algorithm implementations for beginners, 2020.
arXiv:1804.03719.
- [3] S. H. Adachi and M. P. Henderson.
Application of quantum annealing to training of deep neural networks, 2015.
arXiv:1510.06356.

- [4] J. Alcazar, V. Leyton-Ortega, and A. Perdomo-Ortiz.
Classical versus quantum models in machine learning: insights from a finance application.
Machine Learning: Science and Technology, 1(3):035003, jul 2020.
- [5] H. Alghassi, A. Deshmukh, N. Ibrahim, N. Robles, S. Woerner, and C. Zoufal.
A variational quantum algorithm for the feynman-kac formula, 08 2021.
- [6] K. Beer, D. Bondarenko, T. Farrelly, T. J. Osborne, R. Salzmann, D. Scheiermann, and R. Wolf.
Training deep quantum neural networks.
Nature Communications, 11(808), 2020.
- [7] B. Coyle, M. Henderson, J. C. J. Le, N. Kumar, M. Painsi, and E. Kashefi.
Quantum versus classical generative modelling in finance.
Quantum Science and Technology, 6(2):024013, 2021.

- [8] D. J. Egger, C. Gambella, J. Marecek, S. McFaddin, M. Mevissen, R. Raymond, A. Simonetto, S. Woerner, and E. Yndurain.
Quantum computing for finance: State-of-the-art and future prospects.
IEEE Transactions on Quantum Engineering, 1:1–24, 2020.
- [9] F. Fontanela, A. Jacquier, and M. Oumgari.
A quantum algorithm for linear PDEs arising in finance, 2021.
Available in arXiv:1912.02753.
- [10] J. J. García-Ripoll.
Quantum-inspired algorithms for multivariate analysis: from interpolation to partial differential equations.
Quantum, 5:431, Apr. 2021.

- [11] A. Gómez, A. Leitaó, A. Manzano, D. Musso, M. R. Nogueiras, G. Ordóñez, and C. Vázquez.
A survey on quantum computational finance for derivatives pricing and VaR.
Archives of Computational Methods in Engineering, 29:4137—4163, 2022.
- [12] J. Gonzalez-Conde, Ángel Rodríguez-Rozas, E. Solano, and M. Sanz.
Pricing financial derivatives with exponential quantum speedup, 2021.
Available in arXiv:2101.04023.
- [13] T. Goubault de Brugière.
Methods for optimizing the synthesis of quantum circuits.
Theses, Université Paris-Saclay, Oct. 2020.

- [14] D. Grinko, J. Gacon, C. Zoufal, and S. Woerner.
Iterative quantum amplitude estimation.
npj Quantum Information, 7:52, 03 2021.
- [15] L. Grover and T. Rudolph.
Creating superpositions that correspond to efficiently integrable probability distributions, 2002.
arXiv:quant-ph/0208112.
- [16] A. Holmes and A. Y. Matsuura.
Efficient quantum circuits for accurate state preparation of smooth, differentiable functions, 2020.
arXiv:2005.04351.
- [17] S. C. Kak.
Quantum neural computing.
In P. W. Hawkes, editor, *Advances in Imaging and Electron Physics*, volume 94, pages 259–313. Elsevier, 1995.

- [18] P. Kaye and M. Mosca.
Quantum networks for generating arbitrary quantum states,
jul 2004.
arXiv:quant-ph/0407102.
- [19] K. Kubo, Y. Nakagawa, S. Endo, and S. Nagayama.
Variational quantum simulations of stochastic differential
equations.
Physical Review A, 103, 05 2021.
- [20] S. Lloyd, M. Mohseni, and P. Rebentrost.
Quantum principal component analysis.
Nature Physics, 10:631–633, 2014.
- [21] A. Manzano, D. Dechant, J. Tura, and V. Dunjko.
Parametrized quantum circuits and their approximation
capacities in the context of quantum machine learning, 2023.

- [22] A. Manzano, D. Musso, A. Leitao, A. Gómez, C. Vázquez, G. Ordóñez, and M. R. Nogueiras.
A modular framework for generic quantum algorithms.
Mathematics, 10(5), 2022.
- [23] A. Manzano, D. Musso, and Álvaro Leitao.
Real quantum amplitude estimation.
EPJ Quantum Technology, 10(2), 2023.
- [24] G. Marin-Sanchez, J. Gonzalez-Conde, and M. Sanz.
Quantum algorithms for approximate function loading.
Phys. Rev. Res., 5:033114, Aug 2023.
- [25] A. Montanaro.
Quantum speedup of monte carlo methods.
Proceedings of the Royal Society A: Mathematical, Physical and Engineering Sciences, 471(2181):20150301, 2015.

- [26] K. Nakaji, S. Uno, Y. Suzuki, R. Raymond, T. Onodera, T. Tanaka, H. Tezuka, N. Mitsuda, and N. Yamamoto.

Approximate amplitude encoding in shallow parameterized quantum circuits and its application to financial market indicator, 2021.

arXiv:2103.13211.

- [27] M. A. Nielsen and I. L. Chuang.

Quantum computation and quantum information.

Phys. Today, 54(2):60, 2001.

- [28] S.-J. Ran.

Encoding of matrix product states into quantum circuits of one- and two-qubit gates.

Physical Review A, 101:032310, Mar 2020.

[29] V. Saggio, B. E. Asenbeck, A. Hamann, T. Strömberg, P. Schiansky, V. Dunjko, N. Friis, N. C. Harris, M. Hochberg, D. Englund, and et al.

Experimental quantum speed-up in reinforcement learning agents.

Nature, 591(7849):229–233, Mar 2021.

[30] M. Schuld, R. Sweke, and J. J. Meyer.

Effect of data encoding on the expressive power of variational quantum-machine-learning models.

Physical Review A, 103(3):032430, 2021.

[31] V. Shende, S. Bullock, and I. Markov.

Synthesis of quantum-logic circuits.

IEEE Transactions on Computer-Aided Design of Integrated Circuits and Systems, 25(6):1000–1010, 2006.

- [32] A. N. Soklakov and R. Schack.
Efficient state preparation for a register of quantum bits.
Physical Review A, 73:012307, Jan 2006.
- [33] N. Stamatopoulos, D. J. Egger, Y. Sun, C. Zoufal, R. Iten, N. Shen, and S. Woerner.
Option pricing using quantum computers.
Quantum, 4:291, Jul 2020.
- [34] Y. Suzuki, S. Uno, R. H. Putra, T. Tanaka, T. Onodera, and N. Yamamoto.
Amplitude estimation without phase estimation.
Quantum Information Processing, 19:1–17, 2020.
- [35] T. Tanaka, Y. Suzuki, S. Uno, R. Raymond, T. Onodera, and N. Yamamoto.
Amplitude estimation via maximum likelihood on noisy quantum computer.
Quantum Information Processing, 20(9), Sep 2021.

[36] W. Vinci, L. Buffoni, H. Sadeghi, A. Khoshaman, E. Andriyash, and M. H. Amin.

A path towards quantum advantage in training deep generative models with quantum annealers.

Machine Learning: Science and Technology, 1(4):045028, 2020.

[37] N. Wiebe, D. Braun, and S. Lloyd.

Quantum algorithm for data fitting.

Physical Review Letters, 109:050505, Aug 2012.

[38] Z. Zhao, J. K. Fitzsimons, and J. F. Fitzsimons.

Quantum-assisted Gaussian process regression.

Physical Review A, 99:052331, May 2019.

QMC: Risk measures

Find $\text{VaR}_\alpha(X) = \inf\{x : \mathbb{P}[X \leq x] \geq 1 - \alpha\} = \inf\{x : F_X(x) \geq 1 - \alpha\}$:

$$f_J(x) = \begin{cases} 1 & \text{if } x \leq x_J \\ 0 & \text{otherwise} \end{cases}$$

Thus, the original QMC state becomes

$$|\psi\rangle = |0\rangle \otimes \sum_{j=J+1}^{N-1} p(x_j) |j\rangle + |1\rangle \otimes \sum_{j=0}^J \sqrt{p(x_j)} |j\rangle$$

A bisection search over J and measuring $|1\rangle$ gives the $x_{J_\alpha} \approx \text{VaR}_\alpha(X)$

To estimate $\text{CVaR}_\alpha(X)$, take $f(x) = \frac{x}{x_{J_\alpha}} f_{J_\alpha}(x)$, so

$$|\psi\rangle = |0\rangle \otimes \left(\sum_{j=J_\alpha+1}^{N-1} p(x_j) |j\rangle + \sum_{j=0}^{J_\alpha} \left(1 - \frac{x_j}{x_{J_\alpha}}\right) p(x_j) |j\rangle \right) + |1\rangle \otimes \sum_{j=0}^{J_\alpha} \sqrt{\frac{x_j}{x_{J_\alpha}} p(x_j)} |j\rangle$$

and measure $|1\rangle$. Then, $\text{CVaR}_\alpha(X) \approx \frac{x_{J_\alpha}}{1-\alpha} \sum_{j=0}^{J_\alpha} \frac{x_j}{x_{J_\alpha}} p(x_j)$

Using Y-rotations and a comparator (in K), we can construct:

$$\begin{aligned}
 |\psi\rangle &= |0\rangle \otimes \sum_{x_j < K} \sqrt{p(x_j)} |j\rangle [\cos(g_0) |0\rangle + \sin(g_0) |1\rangle] \\
 &+ |1\rangle \otimes \sum_{x_j \geq K} \sqrt{p(x_j)} |j\rangle [\cos(g_0 + g(x_j)) |0\rangle + \sin(g_0 + g(x_j)) |1\rangle]
 \end{aligned}$$

The probability of measuring the second *ancilla* (auxiliary) state $|1\rangle$ is:

$$P = \sum_{x_j < K} p(x_j) \sin^2(g_0) + \sum_{x_j \geq K} p(x_j) \sin^2(g_0 + g(x_j))$$

For a European call ($\max(0, x_j - K)$), set $g(x) = \frac{2c(x-K)}{x_{\max}-K}$, $g_0 = \frac{\pi}{4} - c$.

Thus, using that $\sin^2(cf(x) + \frac{\pi}{4}) = cf(x) + \frac{1}{2} + \mathcal{O}(c^3 f^3(x))$, we have

$$\begin{aligned}
 P &\approx \sum_{x_j < K} p(x_j) \left(\frac{1}{2} - c\right) + \sum_{x_j \geq K} p(x_j) \left(\frac{2c(x_j - K)}{x_{\max} - K} + \frac{1}{2} - c\right) \\
 &= \frac{1}{2} - c + \frac{2c}{x_{\max} - K} \sum_{x_j \geq K} p(x_j)(x_j - K)
 \end{aligned}$$



Algorithms for simulating/loading distributions

Some approaches to compute the initial distribution relies on:

1. Use a general method to convert unitary operators to circuits [13].
2. Use specific methods to initialize the amplitudes to a normalized vector [31, 18, 32].
3. Use the properties of the probability distribution to create an efficient circuit [15, 24].
4. Create an *ad-hoc* circuit using Parameterized Quantum Circuit (PQC) which approximates the amplitudes [26].
5. Using Tensor Networks techniques [28, 16, 10].

Approaches for financial problems which aim to simulate the underlying SDE:

- Analogous SDE simulation with a “quantum” Floating-Point number representation [25]
- Simulate the MC paths using a trinomial tree[19].
- Use Feynmann-Kac approach[5].

Quantum Matrix

Instead of working with a quantum state of the form:

$$|\psi\rangle = \sum_{i=0}^{I-1} \sum_{j=0}^{J-1} c_{ij} |i\rangle_{n_I} \otimes |j\rangle_{n_J} ,$$

we work with a data structure (quantum matrix) storing the same information:

	$ 0\rangle_{n_I}$	$ 1\rangle_{n_I}$...	$ j\rangle_{n_I}$...	$ J\rangle_{n_I}$
$ 0\rangle_{n_I}$	c_{00}	c_{01}	...	c_{0j}	...	c_{0J}
$ 1\rangle_{n_I}$	c_{10}	c_{11}	...	c_{1j}	...	c_{1J}
...
$ i\rangle_{n_I}$	c_{i0}	c_{i1}	...	c_{ij}	...	c_{iJ}
...
$ I\rangle_{n_I}$	c_{I0}	c_{I1}	...	c_{Ij}	...	c_{IJ}

Arithmetic on quantum matrices

- We provide arithmetic operations specifically designed for our framework.
- We distinguish three categories depending on their efficiency.
- The most efficient ones (green) depend on the co-dimension instead of the array's length:
 - Sum and difference.
 - Multiplication by scalar.
- The techniques with middle efficiency (yellow) involve big number of multicontrolled operations but do not depend on an oracle:
 - Permutations in the quantum matrix.
- The least efficient techniques (red) depend on an oracle:
 - Element-wise squaring of an array.
 - Scalar product.

Advantages & Disadvantages

The main advantages of the proposed framework are:

- Easy to understand (the pipeline and the quantum matrix/tensor).
- Good level of abstraction (from the applications perspective and the implementation one).
- Efficient performance for operations on large structures.

Nevertheless, some drawbacks may arise for certain tasks:

- Perform operations on single elements \rightarrow The efficiency depends on the codimension.
- Multiplication of arrays \rightarrow Unitary operators do not produce multiplication.